

PQube[®] 3 Firmware 3.9.12 Release Notes

IMPORTANT NOTE:

This Firmware is applicable to PQube3 Power Analyzer and their variants (PQube 3e/3v/3r/3LV...)

Firmware 3.9.0 ~ 3.9.12 NEW FEATURES

Firmware 3.9.12

➤ New!

- You can now take control of naming the current channels displayed in the web meter pages and GIF files. For example, you can rename the “L6” current channel to “I1 Amp Mains” and the web meters and current trending GIF files will update as shown below.

Meter	Value
L1-N	119.1V
L2-N	119.4V
L3-N	122.0V
N-E	0.04V
L1-L2	206.1V
L2-L3	209.0V
L3-L1	209.3V
E Amp	0.0000A
L6	46.01A
L7	47.75A
L8	54.94A

Web Meters: Before

Meter	Value
L1-N	118.8V
L2-N	119.0V
L3-N	121.1V
N-E	0.04V
L1-L2	205.8V
L2-L3	207.8V
L3-L1	208.1V
E Amp	0.0000A
I1 Amp Mains	45.87A
I2 Amp Mains	49.49A
I3 Amp Mains	55.44A

Web Meters: After

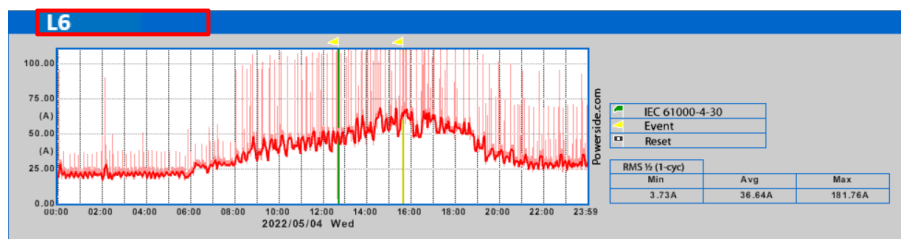

“Individual Current Trends” GIFs Naming: Before

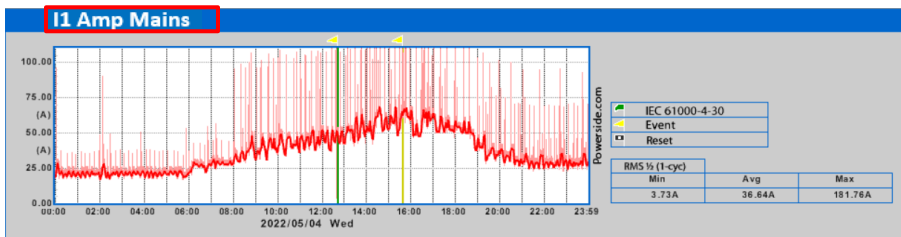

“Individual Current Trends” GIFs Naming: After

- Enhancements made to the PQube 3 dual voltage and dual power mode:
 - You can take control of naming the current channels when using dual voltage and dual power mode. For example, you can rename your current channels associated with the Source 1 voltage (SRC 1) and Source 2 voltage (SRC 2) to “I1 Amp”, “I2 Amp” and “I3 Amp” respectively and the web meters will update as shown below.

SRC 1 Meters		SRC 2 Meters	
Meter	Value	Meter	Value
L1-N	118.8V	L1-N	121.1V
L2-N	119.0V	L2-N	120.9V
L3-N	121.1V	L3-N	121.3V
N-E	0.04V	N-E	0.00V
L1-L2	205.8V	I1 Amp	42.94A
L2-L3	207.8V	I2 Amp	43.16A
L3-L1	208.1V	I3 Amp	43.67A
E Amp	0.0000A	L1-N Voltage Fundamental	121.09V
I1 Amp	45.87A	L1 Voltage Fundamental Angle	0.00deg
I2 Amp	49.49A	L2-N Voltage Fundamental	120.95V
I3 Amp	55.44A	L2 Voltage Fundamental Angle	119.81deg

Web Meters: User Defined Current Channel Naming on Dual Voltage Sources

- Dual Voltage Phasors are now displayed on the web phasors page.

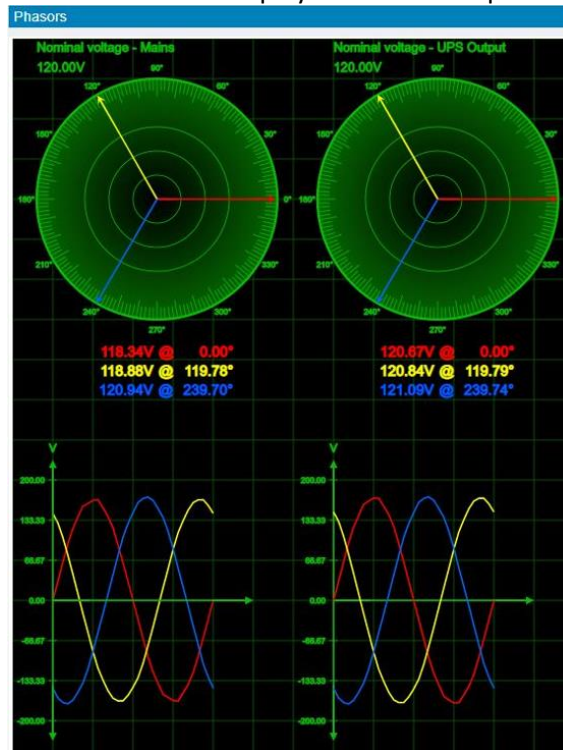

Dual Voltage Phasors Now Displayed

- You can now generate a snapshot while an event is in progress to further enhance your power quality data accessibility.
- Improved overall robustness of the firmware update process:
 - Firmware update function is disabled when the PQube 3 power supply is operating on UPS battery backup.
 - In the event of losing power during the firmware update process, the UPS battery backup timer is automatically extended upon initiation
- Although not related to this specific firmware, the Modbus tool (Modbus client) allows you to use multiple recorders simultaneously for enhanced visibility of real time power quality data. For example, you can simultaneously record 6 meters in the main window, voltage harmonics, and 2-9kHz conducted emissions as shown below.

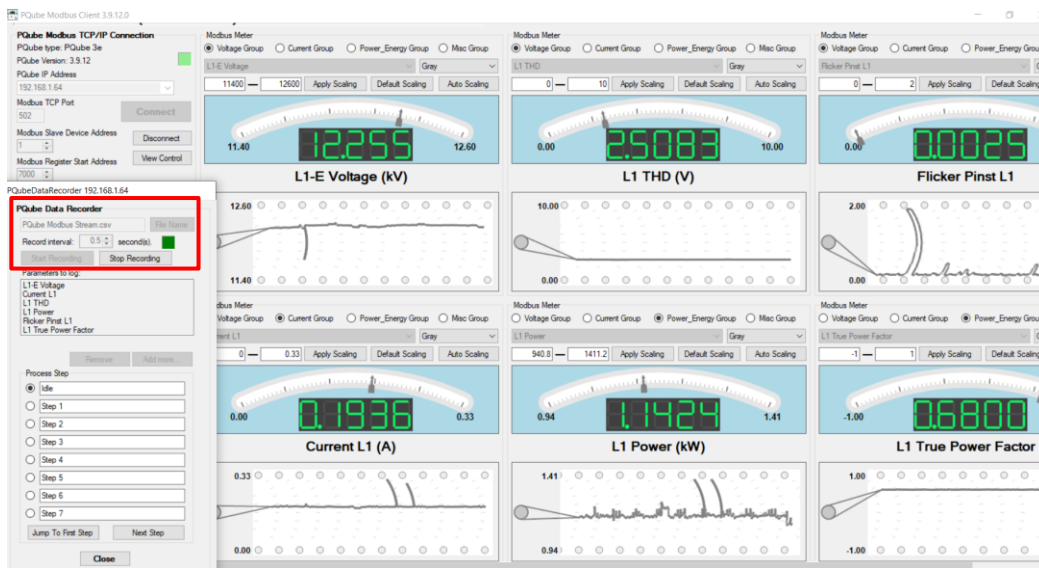

Simultaneous Modbus Recording: 6 meters in the Modbus Mains Window

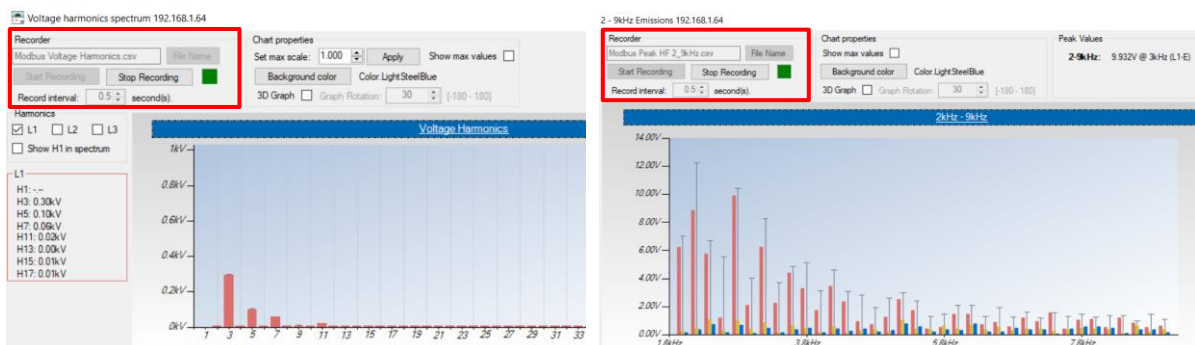

Simultaneous Modbus Recording: Voltage Harmonics & 2-9kHz Conducted Emissions

PQube® 3 Firmware 3.9.12 Release Notes (v1.0)

Doc# 895-000002

Powerside 980 Atlantic Ave, Alameda CA 94501, USA

Tel ++1-510-522-4400 Fax ++1-510-522-4455 www.powerside.com

Firmware 3.9.10

➤ **New!**

A new pre-trigger feature enables extending detection of the pre-fault/pre-trigger recording by double or triple of the default pre-trigger duration. This applies for both RMS and waveform recordings. The figure below shows the default and extended pre-fault recordings for RMS envelope. This feature can be enabled in the PQube 3 configurator software as shown below.

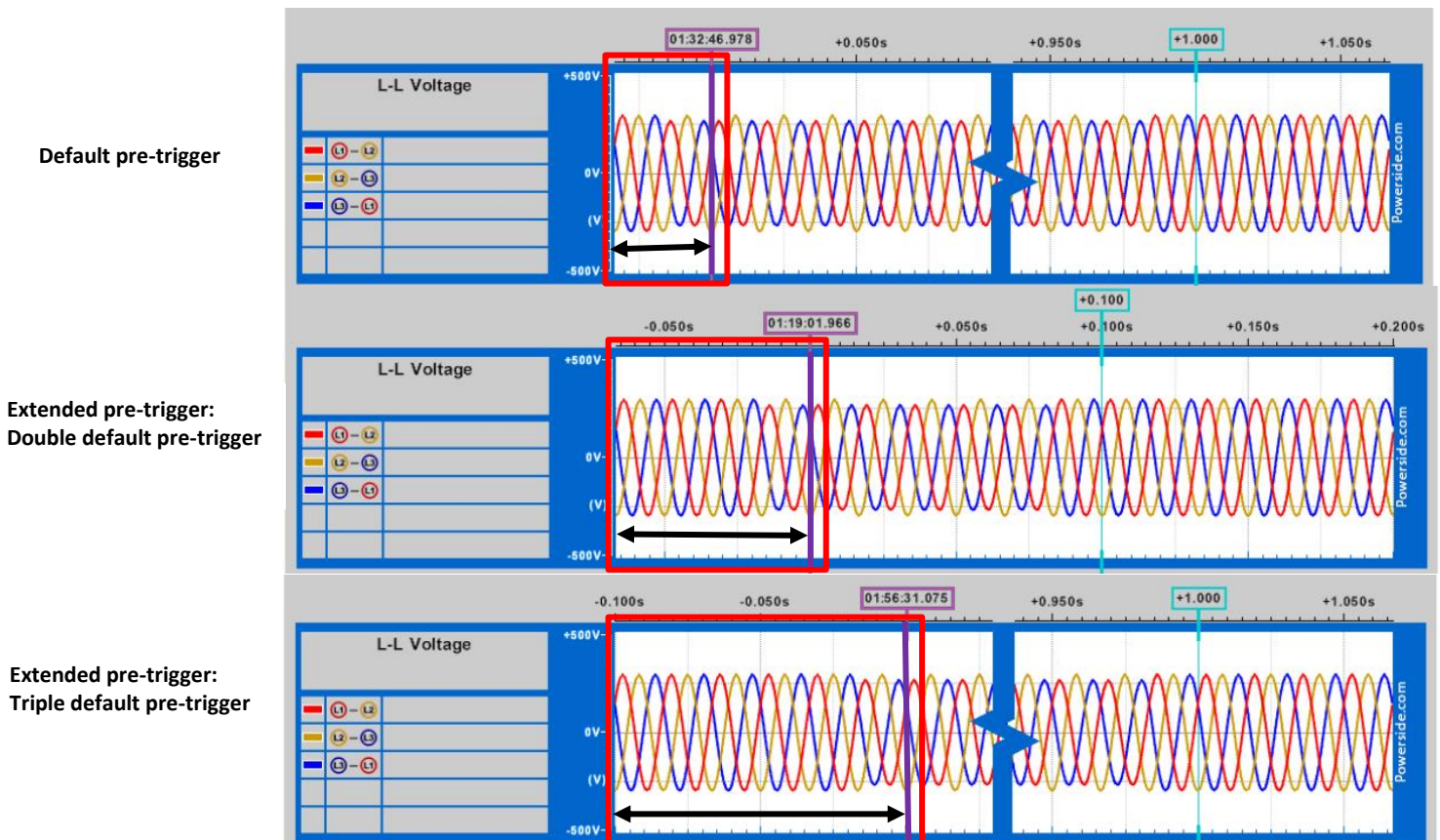

Example of Default, Double and Triple Pre-Fault Trigger Duration for the Waveform Recording

Firmware 3.9.9

➤ **New!**

A new function was added to prevent uploading previous versions of firmware to the PQube 3 locally from the screen display using the USB stick.

Firmware 3.9.8

➤ **New!**

A new type of current trigger to detect a **loss of load** or detect reduced load consumption conditions. Whenever the load current magnitude falls below a configurable threshold, your PQube 3 triggers an event, records an RMS envelope and waveform.

This new event trigger can be configured on top of existing over-current or inrush-current triggers for the current channel. Each of the 8 channels for PQube 3 (14 channels for PQube 3e) can be assigned with an under-threshold with their own individual thresholds.

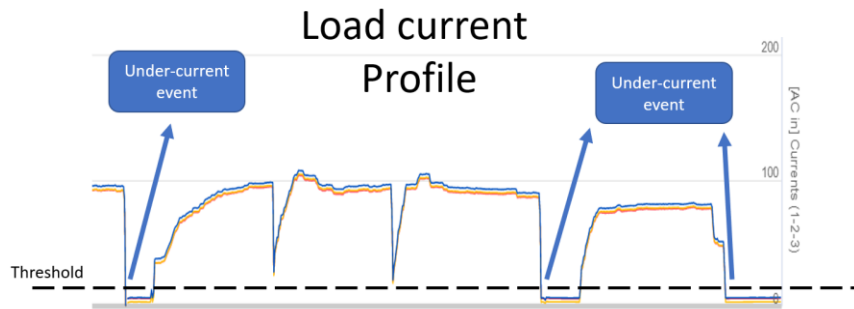

Firmware 3.9.7

➤ 8-150kHz spectrum is now available via MODBUS.

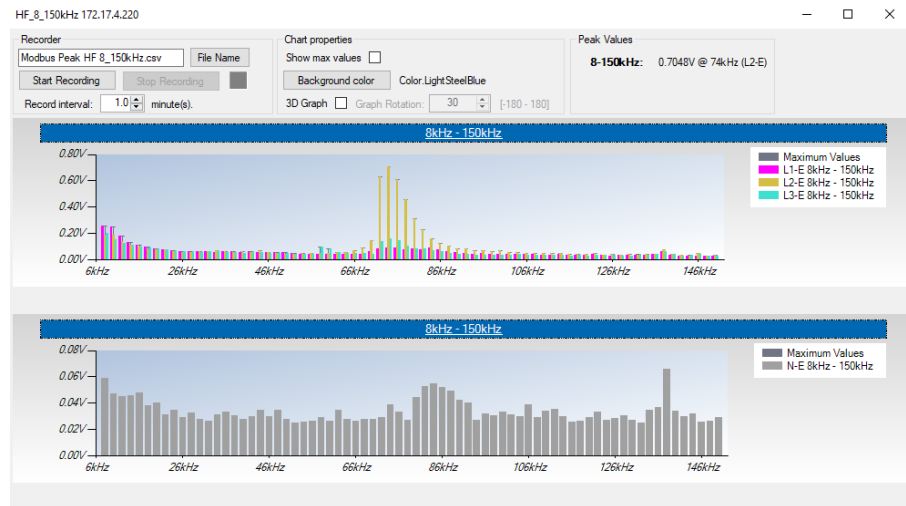

- ENV2 probe temperature channels Fahrenheit support is added for temperature measurements.

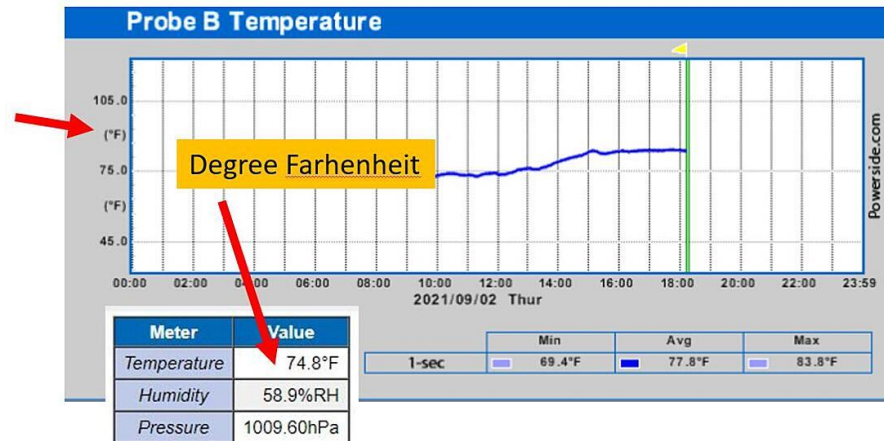

Firmware 3.9.2

- PQube3 web pages now display a phasor diagram and a single cycle waveform shape. It is now very easy to verify wiring and/or commission a PQube3 remotely from the PQube 3 web pages.

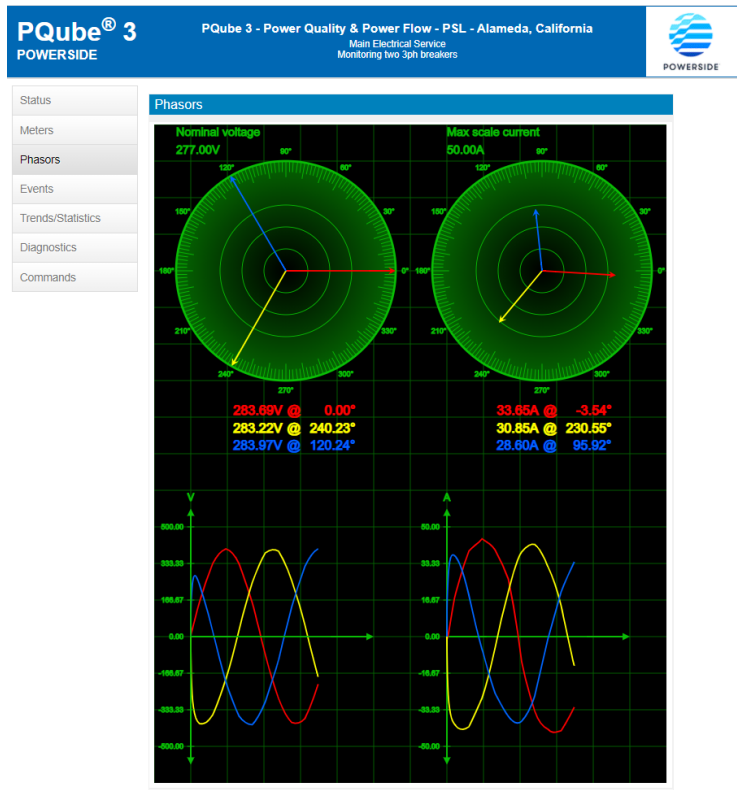

- **New!** The PQube 3 now offers an option to extend the RMS recording length to 4 times the default length. With this option, 4 currents (3 phases +neutral) and 3 (L-N and L-L) voltage, and frequency channels are recorded. the pre-trigger is approximately 3 to 4sec @60Hz.

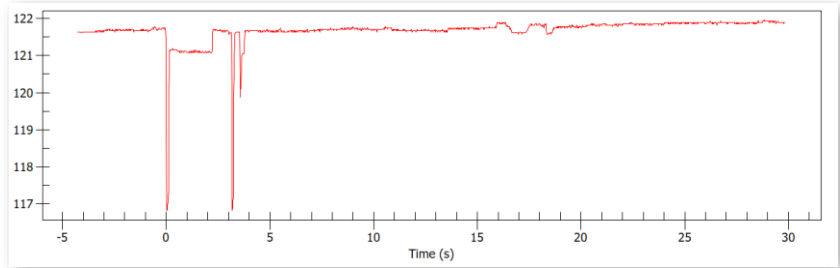

New Extended RMS recording option: ~34 sec @60Hz, ~40sec @50Hz

- **New!** FTP Push: the PQube 3 can now to push event data records to a distant FTP server. This is a BETA version of the functionality.

Firmware 3.9.0 :

- Better diagnostic for technical assistance: added additional log availability for troubleshooting via the downloads page.
- PQDIF file improvement: the PQube 3 now generates a PQDIF file when the event does not contain a waveform recording. (MAGDUR PQDIF tags for this type of event file).

Firmware 3.9.12 Bug Fixes

- Fixed ENV2 probe mechanical shock events causing “event in progress” displayed on the PQube 3 web server status page and an “!” icon events list on screen display.
- Fixed scaling the analog channel GIF event files when negative values are being measured

Firmware 3.9.10 Bug Fixes

- Fixed clearing an invalid message “event in progress” displayed on the PQube 3 status page and Events list on screen display.
- Improved the dual power mode web meter page, screen, and GIFs.
- Fixed waveform recording PQDIF output when voltage or current channel swapping is configured.
- Fixed a 30-degree secondary phase offset issue when in dual voltage delta configuration.
- Fixed TDD values in when “TDD demand current IL” is configured to the AUTO setting.
- Fixed false temperature and humidity events when Fahrenheit mode is selected.
- Identified an issue with wiping the daily trend data from PQube 3 memory when upgrading firmware versions from 3.8.x to 3.9.x. Recommend saving the trending data prior to upgrading firmware.
Note: Upgrading firmware versions from 3.9.x to 3.9.10 will not wipe the daily trend data.

Firmware 3.9.9 Bug Fixes

- Fixed an issue with the under-current trigger event hysteresis parameter.
- Improved the phasor screen waveform view on the webserver.
- Improved the sensitivity of the touch screen display.

Firmware 3.9.8 Bug Fixes

- Fixed a timestamp issue on the 2kHz~150kHz output files.
- Fixed a problem where certain value shows up as “inf” in csv files.
- Corrected some PQDIF file tag names based on TDD setting.
- Fixed an issue with splash.gif uploading on the commands page.
- Fixed an issue with DNP3 not working properly during certain events.
- Fixed an issue with statistics when temperature unit is set to Fahrenheit.

Firmware 3.9.7 Bug Fixes

- Fixed certain inaccurate labelling and recording options under Delta Configuration.
- Fixed an issue where past Power Loss events were not persisting on the Events page.
- Fixed an issue with I14 current events not working properly.

Firmware 3.9.6 Bug Fixes

- Fixed a rare case where THD and Harmonic values can sometimes be inaccurate.
- Fixed an issue where in some cases firmware updates cannot be uploaded.
- Added additional support for multi-circuit PQDIF files.
- Fixed an issue where the daily emails does not send due to size constraints.
- Added some additional PQVIEW compatibility options.

Firmware 3.9.4 Bug Fixes

- Improved shutdown behavior and reliability due to power loss.
- Automatically clean out outdated links when data is deleted due to storage concerns.
- Fixed an issue with phase inconsistencies in PQDIF files in some cases.

Firmware 3.9.2 Bug Fixes

- Fixed an issue where individual phases were missing for Flicker in certain output files.
- Fixed an issue with missing certain channels in PQDIF files for Delta configurations.

Firmware 3.9.0 Bug Fixes

- Fixed a calculation error on TDD for the 10 minutes class A value.
- Fixed a rare occurring bug that could cause the system to crash, mostly observed on 50Hz systems.
- Fixed an issue with power factor display.
- Fixed an issue affecting the automatic importing of certain PQDIF files using PQVIEW.
- Fixed an issue tracking peak power values under certain conditions.

Firmware 3.8.1 - 3.8.4 NEW FEATURES

- PQube 3 now supports communications via the BACnet/IP protocol.
ANSI/ASHRAE 135-2016 BACnet is a data communication protocol for building automation and control networks.
All of the PQube3 meters are available as Data Objects.



- PQube 3 can now generate sag immunity overviews charts - daily, weekly or monthly. Several standard reference curves are available: SEMI F47 (semiconductor industry), MIL-STD-1399 (shipboard equipment), MIL-STD-704E (aircraft electric power), CBEMA (Information Technology), Samsung Power Vaccine...
You can also configure your own curve with 4 control points!

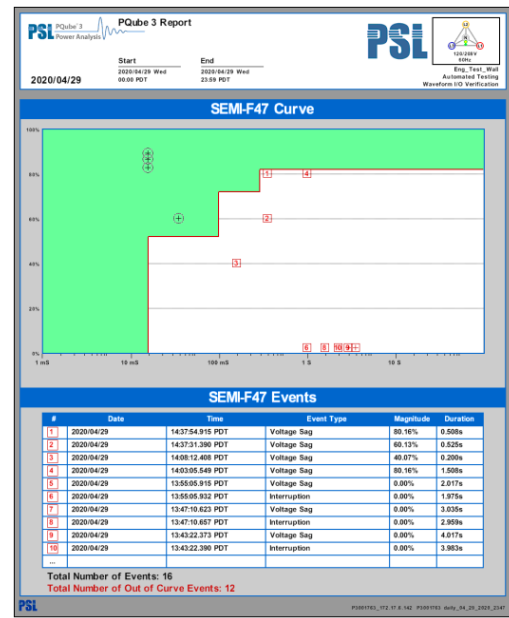

- PQube 3 complies with the IEC 61000-4-30 Ed3 corrigendum 1. Corrigendum 1 clarifies details of the method to compute RVC events (Rapid voltage changes).

- Improved compatibility with PQView V4: option for PQube 3 PQDIF files to be time-tagged in UTC with time zone information, vs. local time.

New in 3.8.4:

- Added an option to restrict access to the screen display with a lock code.
- PQDIF file support for multiple load “power-energy files” with PQube 3 (up to 2 loads), and PQube 3e (up to 4 loads).
- Recording of harmonic power flow direction (H2 ~ H50) during snapshot recording (CSV files).

Firmware 3.8.4 Bug Fixes

- Updated a few security patches.
- Fixed column names on 2kHz ~ 150kHz CSV files.
- Fixed a bug with ejecting removable drives (USB /microSD card).

Firmware 3.8.3 Bug Fixes

- Fixed an issue with weekly trends not being accessible on the web server.
- Fixed an issue where sometimes daily trend emails would fail to send.
- Fixed several PQDIF related issues related to PQVIEW.
- Fixed an issue with 2-150kHz not calculating correctly in single phase mode.
- Fixed an issue where some command buttons appear not functional when configured with certain languages.
- Fixed an issue with an inaccurate SEMI-F47 curve.

Firmware 3.8.1 Improvements

- Added more diagnostic information.
- Added ability to download diagnostic information from the web page.
- Improved robustness in configuration update and firmware update internal process.

Firmware 3.8.1 Bug fixes

- Corrected Power factor values trends (1min daily trends) with firmware 3.8.0.
- Missing daily embedded EN50160 reports, embedded ITIC reports with firmware 3.8.0.

Firmware 3.7.0 thru 3.7.9 FEATURES

- Your PQube 3 now delivers a daily, weekly or monthly sag/swells graphic summary: the embedded ITIC graph summary.
The ITIC graph is a 2D magnitude/duration plot of the sag/swell/interruption events that occurred during the period. Events plotted outside the 2 curves are typically considered as impacting equipment, so considered as a problem.
You also get a list of events (up to the 10 most recent ones) below the ITIC graph.

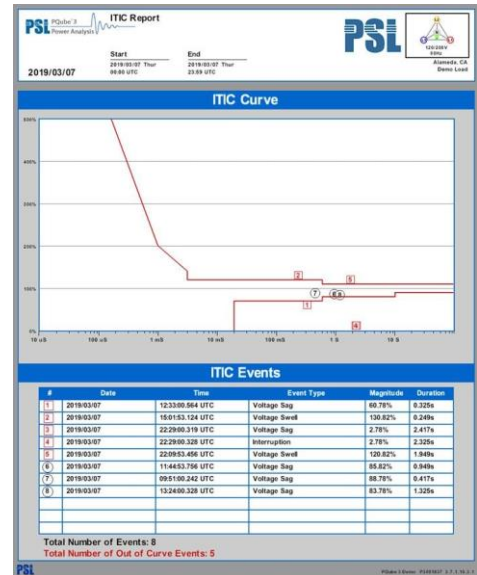

- Your PQube 3e* now has a new “Dual power” mode:
With this mode, you can simultaneously monitor the input and the output power of a UPS, or the primary and secondary side of a transformer.
As a result, the PQube 3e will also monitor in real time the efficiency of the equipment. The efficiency is defined as the ratio of output active power to the input active power.
(*) this feature requires a PQube 3e and a VAT1 module.

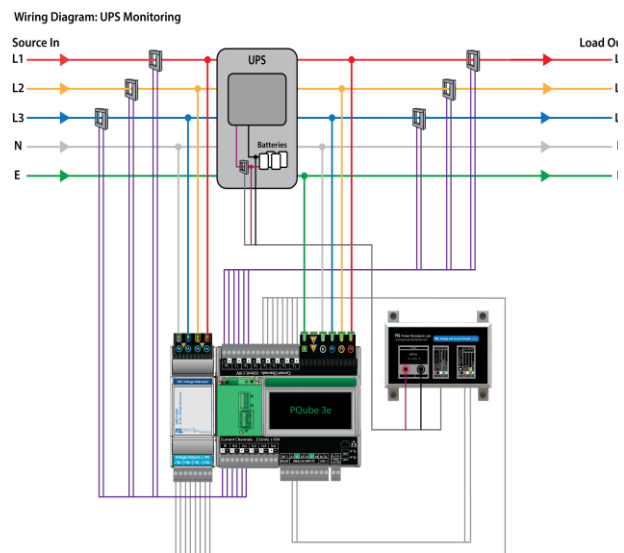

- You can now use your PQube 3 as a controller to limit consumption by shedding non-critical loads of your monitored circuit.

With this new function (RM8, 8-relay extension module required) you can define a load shedding scheme to prevent your circuit protection from tripping because of overconsumption. To do this, you define the power threshold(s) above which the (RM8) relays that will shed the non-critical loads.

With a PQube 3, you can monitor and have up to 2 (3-phase) circuit shedding schemes. A PQube 3e lets you have shedding schemes for up to 4 (3-phase) circuits.

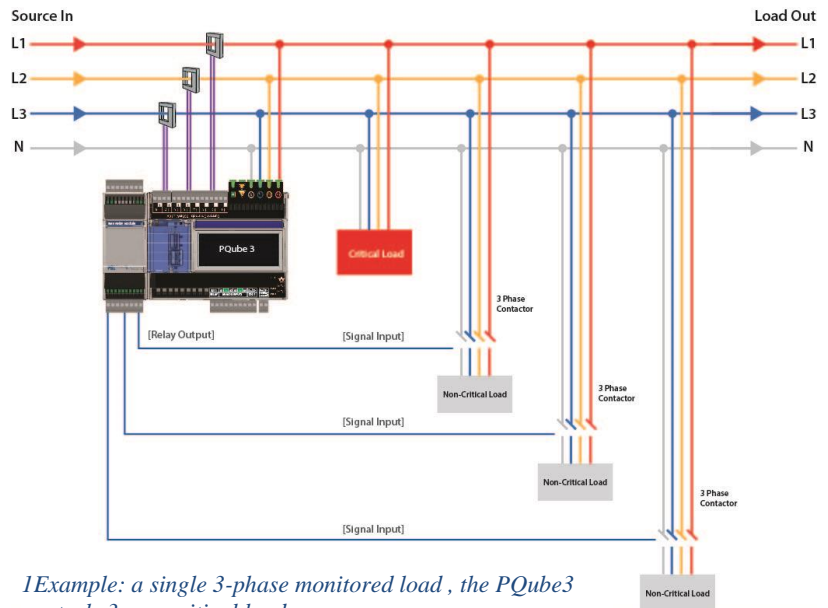

Example: a single 3-phase monitored load, the PQube3 controls 3 non-critical loads

- The PQube 3 can now detect and signal low (or loss of) power. The 'low' condition threshold can be set in the configuration (this function requires an RM8 module).
- The PQube 3 can also detect and signal reverse power flow (import to export power) if the threshold is set to 0.0, the power monitored will go from positive to negative and vice versa (crossing the zero threshold)

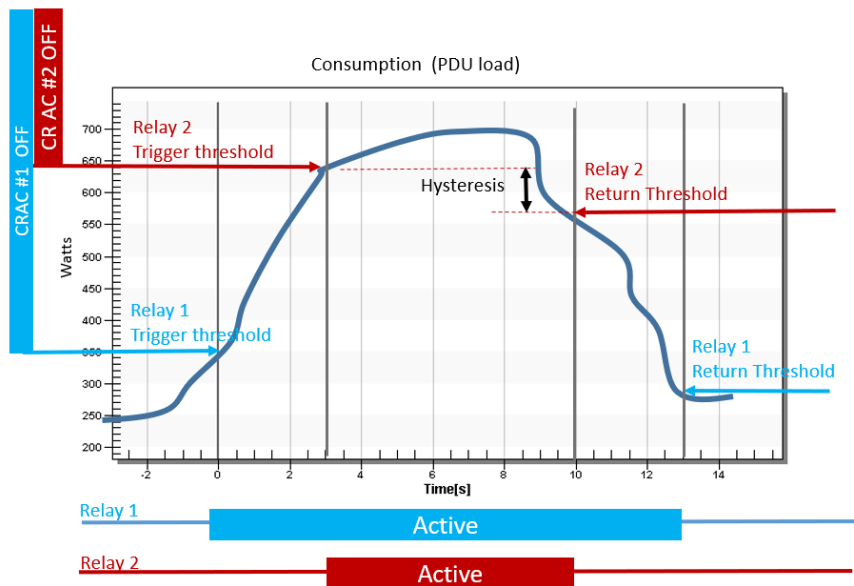

Example of a 2-threshold load shedding.

It is possible to monitor up to four 3-phase loads (PQube 3e) with up to 8 thresholds

- *Note1: firmware 3.7 or higher is required to operate PQube 3r (PQube 3 model with 3 additional relays) or a PQube 3 with the RM8 module*

Firmware 3.7.9 Improvements

- All of the PQube 3 pages (including the Command page) are accessible on the same port.
- Improved compatibility of PQube 3 PQDIF files with PQView, including PQView v4.
- Improved the EN50160 embedded report to better represent the standard (harmonic ranks>25).
- Fixed some string inconsistencies between various output files of the PQube 3.
- Improved reliability and behavior on the UPS3 module to reduce downtime when the battery is being charged.
- Clarified return error message when setup.ini cannot be updated in certain cases.

Firmware 3.7.5 Improvements

- Option to record individual current harmonics in %IL, or in Amps. The rated current (IL) can be defined in the PQube3 configuration.

Firmware 3.7.4 Improvements

- PQDIF file for 10sec frequency measurements is now available.
- PQDIF trends phase identifier adapted for DELTA configuration.
- PQDIF event RMS recording compatibility with PQView improved

Firmware 3.7.3 Improvements

- Improvement of the behavior of the PQube3 shutdown procedure (upgrade to 3.7.3 is recommended if PQube3 is operating with a UPS1, UPS2, or UPS3 module)
- Improved compatibility of PQDIF harmonic files for viewing with PQView V3 software

Firmware 3.7.1 Improvements

- Present week “weekly trend”, and present month “monthly trend” can be generated remotely using the Web command page. (This can also be used to generate trends in the past that were not generated previously).
- Configuration of PQube 3 current input channel range (333mv/10V) on each individual channel (I4 through I14)
- Language support for the 3.7.0 new features in Spanish(South America), Portuguese(Brazil), Portuguese(Portugal), Italian, German, Polish, Danish, Swedish, French, Dutch.

Firmware 3.7.0 Improvements

Web interface:

- Compatibility with Microsoft Edge (Internet Browser)
- You have a faster Web page interface: especially faster response for the diagnostic page and faster response when in secure HTTP mode (HTTPS).
- The remote firmware upgrade via the web page is simplified (single step [send] button).
- Upload configuration file: you may now have any name with extension ".INI".
- Upload location and splash logo GIF files: you may now use any file name with extension ".GIF"
- PQube 3 status page, displays "Event capture in progress" as long as an event is being recorded. This matches the exclamation mark on the PQube 3 screen display.
- The email result on the command page after completion...
- Counter of events refreshes automatically on the web page
- The diagnostic page now displays the result code of the (last) test email

Synchronization:

- Synchronization: NTP and SNTP faster acquisition at startup, or when the Ethernet cable is connected.
- The screen displays a "lock" symbol when SNTP/NTP synchronization is active, and no symbol displayed when synchronization is lost.

Mains signaling:

- Mains signaling (ripple control signal) is now available as a CSV triggered recording (as per IEC 61000-4-30)

Miscellaneous:

- The overcurrent trigger event summary now reports the trigger threshold
- Power factor meters now displayed and recorded with 3 digits after decimal
- Differential analog AN1-AN2 and AN3-AN4 names can now be defined in configuration
- Vertical zoom limited for current channels to avoid auto zooming in on noise (event GIF files)

PQDIF:

- PQDIF file generation speed performance improved (events and trends)
- Improved compatibility of PQDIF files for viewing with PQView V3 software
- PQDIF files generated for the power/energy files
- PQDIF: sag and interruption events without recording are now generated as MAGDUR types events
- PQDIF trends generated (separate files) when using dual voltage and dual power measurements mode

Firmware 3.7.9 Bug fixes

- Fixed a rare issue which caused emails to stop working.

Firmware 3.7.8 Bug fixes

- Production related correction for PQube 3r

Firmware 3.7.7 Bug fixes

- Production related correction

Firmware 3.7.6 Bug fixes

- Corrected PQDIF channel label “voltage magnitude” to reflect Phase -to neutral (L-N) or Phase to Phase (L-L).

Firmware 3.7.3 Bug fixes

- correction of an issue with PQube3 and microPMU synchronization by GPS (GPS1-MS1).

Firmware 3.7.1 Bug fixes

- DNP3 “Source_Id” can now be changed by configuration
- Dual power mode: fixed efficiency meter jumping from 200% to 0.00% (when no voltage applied to input or output)
- Fixed a specific issue in a rare scenario with AUTO power configuration, AUTO nominal voltage , and fixed nominal frequency.

Firmware 3.7.0 Bug fixes

- Fixed rare issue with trends or events missing (internal memory filling up)
- Trends do not generate after the data is cleared.
- Fixed an issue with the screen diagnostic displaying a “Counter clockwise” rotation, whatever the setting defined in the configuration.
- 10-minute trends now record voltage inter-harmonics in “% of fundamental” when the option is selected in the configuration.
- In single phase mode, the CSV columns for L2-N, L3-N, L1-L2, L2-L3, L3-L1 are now not populated.
- Negative and zero sequence (voltage and current) were swapped in daily/weekly statistical tables
- Weekly and Monthly GIF trends showed min/avg/max table value as "0" if only weekly and monthly trends are enabled.
- “Power_energy” CSV files now use the field separator defined as per the configuration.
- Fixed miscellaneous PQDIF channel definition issues
- Trends may not generate (rare) after the data is cleared from memory
- Daily trends did not generate after Jan 6th (when weekly trends are enabled) until they are reset. The daily trends can be recovered with this firmware.

Known issues:

- 2kHz-150kHz emission CSV file always uses “,” as separator independently of the option set in the configuration.
- 10 sec frequency daily trends CSV separators cannot be changed from “;”
- 2-hour daily trend CSV separators cannot be changed from “;”
- GIF trends Apparent Power kVA scale wrong for Rogowski coils and split-core CTs
- Partial translations (e.g. dual power mode),
- Command page Korean not translated.

- Display screen freezes after auto config (rare)

- When 2 ENV2 probes are connected and (each of) their serial number are not declared in config, the ENV2 (probe A) only will trigger.

- More detailed 2 kHz – 150 kHz conducted emissions color maps:
 - Phase by phase color maps, allows you to visualize which specific phases are contributing the most to creating conducted emissions
 - Distinct color map scale for the low and high range of conducted emissions: one for 2 kHz – 9 kHz, and another one for 8 kHz – 150 kHz.

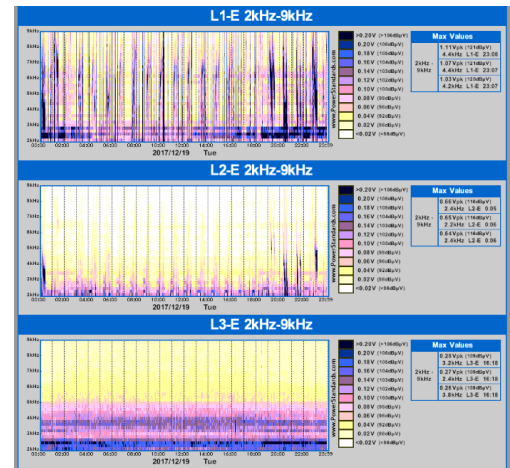

- It is now possible to declaring the offset voltage of a sensor output that is connected to the PQube 3 analog channels. The offset declared can be specific to each individual analog channel.

Firmware 3.6.0 (and higher) Improvements

- Dual voltage mode VAT1-600 improvements:
The firmware now takes into account the VAT1 4th voltage output. It is interpreted as Neutral-to-Earth voltage (N-E) channel of the second voltage group. This N-E channel can trigger events and is trended in GIF files.
- SNTP-NTP lock/unlock sign
- In Event GIF graphs, the Neutral to Earth channels auto-zooming will be limited to avoid showing quantization noise (max zoom in limit on the waveform graph)
- The PQube 3 now displays model names (e.g. “PQube 3v”) instead of the production part number) in screen, web pages, files, emails
- PQube 3 now shows the firmware update is in progress by having the main status LED blinking in light blue color.
- Norwegian missing translations added.
- The 10 min interval trends CSV file now includes (besides the average value) the maximum values over that 10 min period. This is for each individual harmonics from H2 to H50.
- PQube 3 will now accept configuration file names with or without capital: Setup.ini or setup.ini
- Option to clear all emails from the pending email queue after the PQube 3 has restarted.
- Version 3.6.3: diagnostic web page now displays hardware revision number of the ENV2 EnviroSensor
- Version 3.6.3: when there is an event in progress, the exclamation mark (!) shows up in the bottom of all of the PQube 3 screens



- Version 3.6.4: The weekly EN50160 embedded report (GIF) was taking up to 40 mins. Now optimized and generated in a few minutes.
- Version 3.6.4: added “clear measurement data” button in the PQube 3 command page. This has the same behavior as the screen [Clear] button. It erases all events and trends from internal memory. IT does not erase the configuration, calibration
- Version 3.6.4: Increased touch screen function reliability – fixes rarely observed “screen frozen” symptoms.

Firmware 3.6.4 Bug fixes

- Fixed a rare occurrence where the HF impulse waveform recording is wrong.
- Fixed a threshold mistake in EN50160 embedded report. The positive threshold of the “RMS voltage 100%” limit was set to 15% instead of 105% as per the standard.
- Fixed a rare occurrence with handling of burst of HF impulses or mechanical shocks/seismic events, that caused PQube 3 to stop generating HF impulse and EnviroSensor probe events.
- Fixed an issue where the PQDIF file containing the shape of the HF impulse form is missing.
- Fixed a rare occurrence of an issue where PQube 3 does not regenerate the previous day trend, after restart, if it was off at the time of the trend generation (midnight).

Firmware 3.6.3 Bug fixes

- Fixed a rare occurring bug which can sometimes result in excessive status logging into the PQube 3 log files. When this happens, over time it reduces the capacity of PQube 3 to keep older measurement data. If you suspect you have a reduced amount of measurement in memory, contact technical support.
- Fixed the amplitude of HF impulses in GIF graphs (previously displayed in units multiplied by the transformer ratio, although it should not).
- Fixed time tagging of events when using a time zone with time offset not a integer number (e.g. India offset GMT + 5h 30 mins)
- Firmware now accepts ‘auto’ as well as ‘AUTO’ for tags in setup.ini
- Minor drawing improvements of the embedded EN50160 Report GIF file
- Screen display duration instead of counts of events (event overflow mode ON)
- Seismic trigger threshold (in g units) now displays with 4 digits after decimal (previously displayed 2 digits). Fixed an malformed XML format for summary events (P300XXXX_Event.xml)
- Specific to PQube 3e:
When selecting different current channel ranges (HIGH/LOW) for I1~I8 and I9~I14 (rare case), the current magnitude was inaccurate. This has been fixed.

Firmware 3.6.2 Bug fixes

- Fixed an issue in the 2 kHz – 150 kHz CSV file (max values are replaced by average values in the file). The 2 kHz – 9 kHz CSV file was not affected by this issue. Upgrading to the new firmware version is strongly recommended.

Firmware 3.6.1 Bug fixes

- Fixed an issue (rare occurrence) with ENV2 EnviroSensor probe issue: crashes or stops responding. Upgrade firmware is strongly recommended,
- Fixed (event) SNMP trap indexing issue: trap OID were not correct.

Firmware 3.6.0 Bug fixes

- Modbus battery voltage and current, charge registers are now correct
- In some cases, events and trend files cannot be accessed via the Web page (“error 404 file not found”)
- Fixed some rare and random occurrences of frequency max value recorded at an abnormally high level in daily/weekly/monthly trends. This can cause triggering over-frequency events.
- Fixed the following issue: PQube 3e displays load currents for I6, I7 and I8 although their recording tag is set to OFF.
- Wrong format for field separator with PowerEnergy CSV files, and 2 kHz – 150 kHz CSV files when the separator is not set to “;” (default).
- PQube 3 does not calculate the neutral current correctly unless you enter CT ratio on I4
- Split-phase mode power incorrect if the third current channel is connected

Firmware 3.6.x (3.6 version series) Known issues

- 3.60 through 3.6.2 : PQube 3e:
When selecting different current channel ranges (HIGH/LOW) for I1~I8 and I9~I14 (rare case), the current magnitude will be inaccurate. Present workaround: select the same range for both groups I1~I8, and I9~I14.
- Split-phase wiring configuration: although this does not apply, the I3 channel is displayed in GIF graphs, screen display. Although this does not apply, L3-N power is displayed. total power takes into account connected load on I3.
- Split-phase wiring configuration:
Imbalance (negative and positive) are displayed /recorded although this does not apply

Firmware 3.5.x features and improvements

- Support for PQube 3v (version 3.5.6)
- Power/energy computed on all 8 (or 14*) current channels
 - up to 8 X single phase loads, or up to 2 x 3-phase loads with PQube 3
 - up to 14 X single phase loads, or up to 4 x 3-phase loads with PQube 3e
 - 4-Quadrant energy metering for each load:
kW, kVA, kVARs, CosPHI (DPF) or TPF.
kWh (net, import, export), kVARh (net, positive, negative)
 - real time meters on web meter page, and display screen
 - all accessible via Modbus registers
 - User defined (3, 5, 10, 15, 30 mins) interval power/energy recording file
- PQube 3 can record up to 4 events with RMS and waveform, simultaneously or back to back
- PQube 3 supports up to 8 (or 14*) PSL flexible CT's (Rogowski coils), no integrator, no power supply needed! (*)14 channels for PQube 3e
- Automatic Daylight Saving Time management, easy configuration with the PQube 3 configurator
- PQube 3 records 4MHz HF impulses and shows their position in the waveform (RMS also recorded)
- RVC (Rapid Voltage change) events now have a RMS and waveform recording
- Current harmonic distortion : TDD or THDi, user selectable
- Weekly and monthly statistics added
- Nightly measurement data backup (files copied every day) to USB drive or external micro SD card.
Option is enabled by default
- Uploading of PQube 3 Screen logo (splash.GIF) remotely via Web command page
- Uploading of PQube 3 GIF graph and Web page logo (location.GIF) remotely via Web command page
- New 2kHz-150kHz conducted emission with separate 2kHz-9kHz spectrum and 8kHz-150kHz spectrum – with each their own color map
- Separate 2kHz-9kHz Max emission meter, and 8kHz-150kHz Max emission meter (screen display and web meter page)
- Ultra-precise CT's and CTI-1A/5A harmonic frequency response (up to H50) compliant to IEC 61000-4-30 Ed3
- The HF impulse 4MHz single channel trigger mode allows to choose between L1-N or N-E in single phase mode
- Both fundamental voltage amplitude AND angle displayed on the Web meter page
- Peak demand/ peak load current registers can be reset separately from energy accumulators
- CSV files may be excluded from email attachments (option)
- Daily statistics for THD and frequency added
- Improved graph vertical scaling for ENV2 Accelerometer – mechanical shock/seismic disturbance
- The user can define the vertical scaling of the accelerometer recording in daily/weekly/monthly trends
- EnviroSensor probes names (user defined) are displayed in the daily/weekly/monthly trend graphs

- Company logo (splash.gif) can be seen on the main screen display by pushing on the PSL blue banner
- Auto-detection of the power configuration at 50Hz and 100VAC (e.g. in Japan)
- More user friendly definition of the digital input parameters
- PQDIF files compatibility with PQVIEW improved (e.g. harmonics), also includes the PQDIF index file
- Slovakian, Croatian, Hebrew, Portuguese, Russian, Korean language translations improved
- Implemented SNMP registers and traps for PQube 3e current channel parameters I9 ~ I14.
- Addressed network security vulnerability issue (Dropbear v2017.75)
- Improved application stability – (fixes some rare cases of sudden restart)
- Added support for VAT1 module.
Firmware 3.5.2 must be installed to operate with a VAT1 module!
- Added a **visual verification of the L1-L2-L3 phase wiring**. If the wiring sequence is correct, the display screen shows a green check mark, if the sequence is incorrect, the screen shows a RED cross. It is possible to define the rotation convention (counter-clockwise =default, or clockwise with a configuration tag “*Rotation_Convention_On_Vectors_Screen*” (see configurator for more information).
- **PQube 3e**: event recording are now showing all 14 current channels (if they are configured to be displayed).
- Added **fundamental currents** amplitude and angle for on the Web meter page
- **PQube 3 relay**: relay operation behavior is aligned with PQube Classic relay operation. Relay is normally Closed (NC), and opens on event occurrence. Firmware 3.5.0 and lower implement a normally open behavior.
- **PQube 3e**: all 14 currents min/max tables reported in daily trends tables

Firmware 3.5.x Bug fixes

- Power Energy CSV file (power and energy at a user defined interval) – the values recorded in the CSV file are wrong since the last Daylight saving time date (March 2017).
- For measurements at 400Hz nominal frequency, the PQube 3 does not lock on signal.
- (Rare) Harmonic snapshot GIFs are incomplete or not generated in the Wye configuration, if the tag “Record_Phase_To_Phase_Channels ” is set to ON.
- Miscellaneous PQDIF bug fixes
- When the monthly email CSV attachment exceed 16 MB, the CSV file is split in several CSV files to remain under that size limit.
- 10 sec frequency recording file is not generated (with firmware 3.5.0)
- Chinese, Korean (non ASCII character) language translations do not work after upgrading from 3.4.0 to 3.5.0.
- When using flexible CT’s (large ratio), power units show MW although the value should be in kW.
- When using Analog channels with large ratios, the vertical scale is wrong (e.g. 1000kV vs. 1000V)

- Digital channel does not show in trends after a setup change that enables the digital channel recording, until the next day
- Analog channel GIF in trends do not show the user configured label
- Daily trends are not generated if the configuration tags “region of interest” are set to AUTO
- Removed debug file in the HF impulse event file folder
- Analog channel min/max are incorrect in daily trends (rare occurrence)
- RVC events now show as an exclamation mark on the screen display , event counter is now incremented with RVC events
- ‘AN1-AN2’ or ‘AN3-AN4’ waveforms displayed inverted in the event GIF graphs
- Web meter angles are now all relative to Voltage phase L1-N

Firmware upgrade from 3.4.x: important information



This firmware implements some changes in the PQube 3 internal recording structure. After firmware upgrade from version 3.4.x:

(1) the first daily trend file after firmware upgrade will contain only a partial day : from the time of the firmware upgrade to the end of the day. The previous part of the day trend measurements are lost.

(2) the first weekly and monthly trend files after firmware upgrade will also contain partial measurements: from the time of upgrade to the end of week, or month.

(3) PQube 3 resets to zero the PQube 3 energy accumulators.